

Part Number: L-3DP3C

Features

- Mechanically and spectrally matched to the infrared emitting LED lamp.
- Water clear lens.
- RoHS compliant.

Description

Made with NPN silicon phototransistor chips.

Package Dimensions

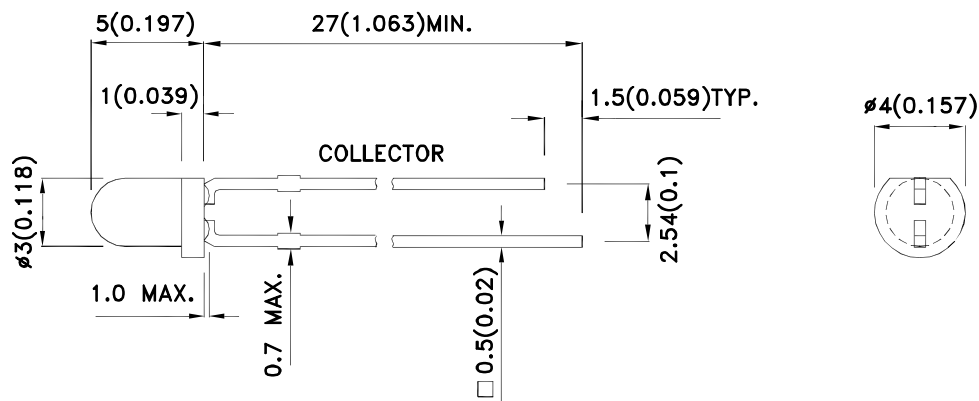

Notes:

1. All dimensions are in millimeters (inches).
2. Tolerance is $\pm 0.25(0.01)$ " unless otherwise noted.
3. Lead spacing is measured where the leads emerge from the package.
4. The specifications, characteristics and technical data described in the datasheet are subject to change without prior notice.



Electrical / Optical Characteristics at TA=25°C

Symbol	Parameter	Min.	Typ.	Max.	Units	Test Conditions
V _{BR CEO}	Collector-to-Emitter Breakdown Voltage	30			V	I _C =100uA E _e =0mW/c m ²
V _{BR ECO}	Emitter-to-Collector Breakdown Voltage	5			V	I _E =100uA E _e =0mW/c m ²
V _{CE (SAT)}	Collector-to-Emitter Saturation Voltage			0.8	V	I _C =2mA E _e =20mW/c m ²
I _{CEO}	Collector Dark Current			100	nA	V _{CE} =10V E _e =0mW/c m ²
T _R	Rise Time (10% to 90%)		15		us	V _{CE} = 5V I _C =1mA R _L =1000Ω
T _F	Fall Time (90% to 10%)		15		us	
I _(ON)	On State Collector Current	0.3	0.8		mA	V _{CE} = 5V E _e =1mW/c m ² λ=940nm
2θ _{1/2}	Angle of half sensitivity		50		deg	

Absolute Maximum Ratings at TA=25°C

Parameter	Max.Ratings
Collector-to-Emitter Voltage	30V
Emitter-to-Collector Voltage	5V
Power Dissipation at (or below) 25°C Free Air Temperature	100mW
Operating Temperature	-40°C To +85°C
Storage Temperature	-40°C To +85°C
Lead Soldering Temperature (>5mm for 5sec)	260°C

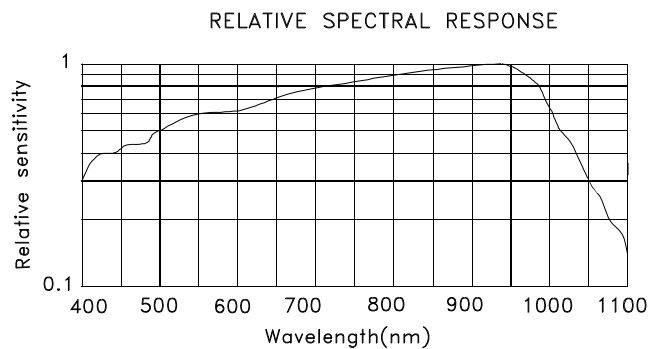

PACKING & LABEL SPECIFICATIONS

L-3DP3C

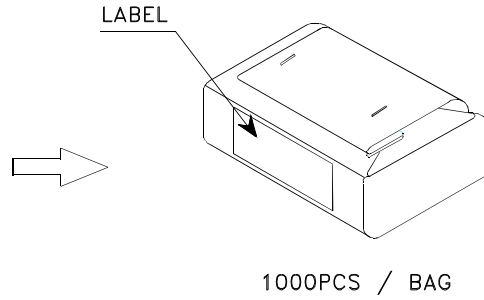
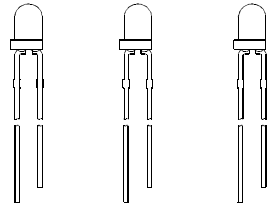

56K / 9# BOX

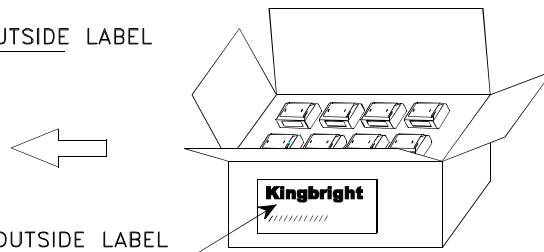

28K / 5# BOX

<h1>Kingbright</h1>	
P/NO: L-3Dxxx	
QTY: 1,000 pcs	Q.C. Q C xx xx xxxx PASSED
S/N: XXXX	
CODE: XXX	
LOT NO:	
	
RoHS Compliant	

PRECAUTIONS

1. The lead pitch of the LED must match the pitch of the mounting holes on the PCB during component placement. Lead-forming may be required to insure the lead pitch matches the hole pitch. Refer to the figure below for proper lead forming procedures. (Fig. 1)

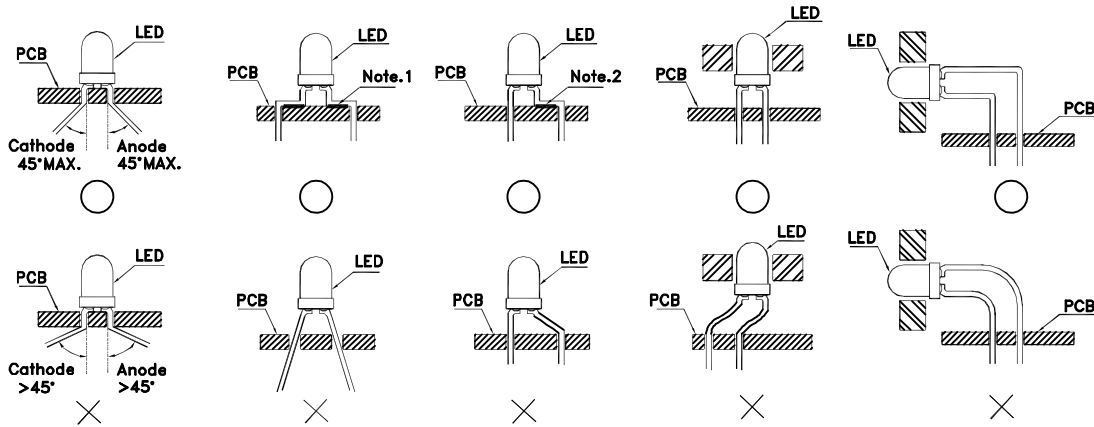

Fig.1

”○” Correct mounting method ”×” Incorrect mounting method

2. When soldering wire to the LED, use individual heat-shrink tubing to insulate the exposed leads to prevent accidental contact short-circuit. (Fig.2)

3. Use stand-offs (Fig.3) or spacers (Fig.4) to securely position the LED above the PCB.

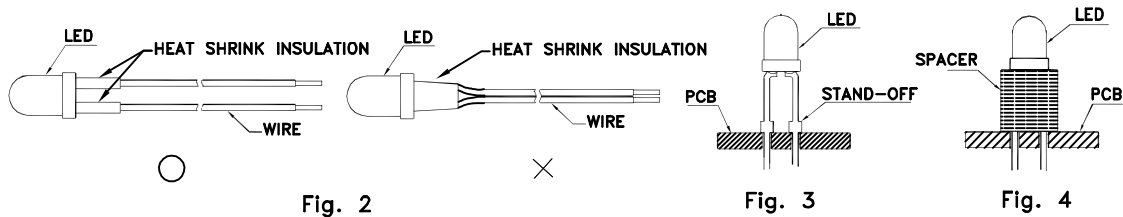

Fig. 2

Fig. 3

Fig. 4

4. Maintain a minimum of 2mm clearance between the base of the LED lens and the first lead bend. (Fig. 5 and 6)
5. During lead forming, use tools or jigs to hold the leads securely so that the bending force will not be transmitted to the LED lens and its internal structures. Do not perform lead forming once the component has been mounted onto the PCB. (Fig. 7)

6. Do not bend the leads more than twice. (Fig. 8)

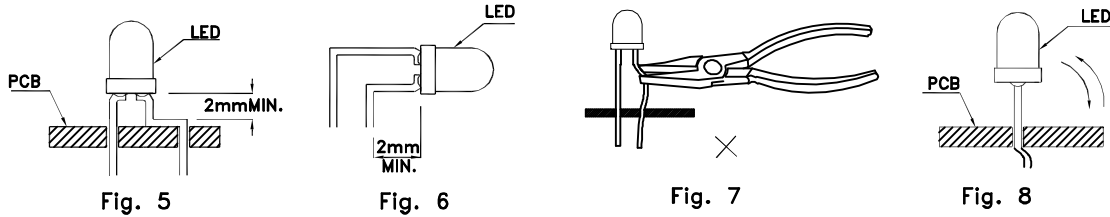

7. During soldering, component covers and holders should leave clearance to avoid placing damaging stress on the LED during soldering.

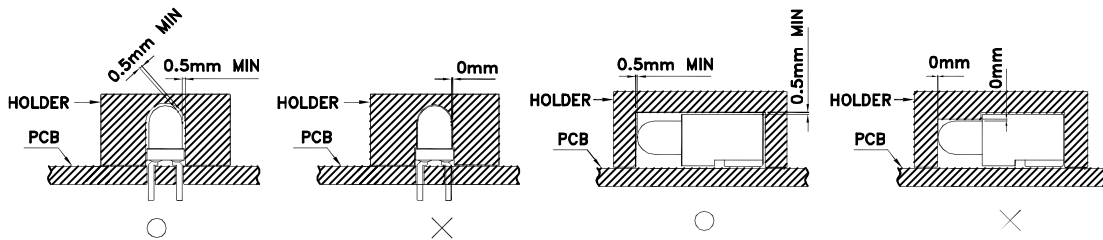

8. The tip of the soldering iron should never touch the lens epoxy.

9. Through-hole LEDs are incompatible with reflow soldering.

10. If the LED will undergo multiple soldering passes or face other processes where the part may be subjected to intense heat, please check with Kingbright for compatibility.

11. Recommended Wave Soldering Profile for Kingbright Thru-Hole Products

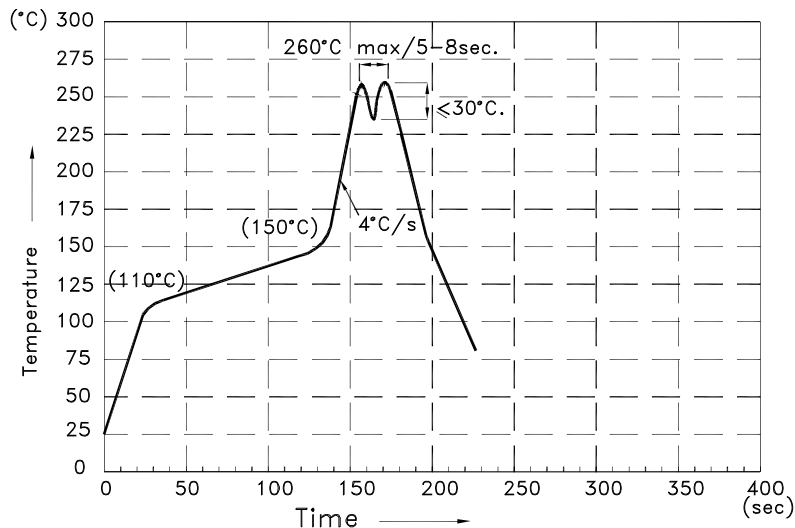

NOTES:

1. Recommend the wave temperature 245°C~260°C. The maximum soldering temperature should be less than 260°C.
2. Do not apply stress on epoxy resins when temperature is over 85°C.
3. The soldering profile apply to the lead free soldering (Sn/Cu/Ag alloy).
4. During wave soldering, the PCB top-surface temperature should be kept below 105°C.
5. No more than once.